



Power and Performance

For The Steel Industry



Innovation in Motion **TSUBAKI**

At Tsubaki we know customers want the best. Indeed, we take pride in our ability to deliver an extensive product line up that satisfies these high expectations. We are also aware that each and every one of our customers has unique requirements. Therefore, we believe that in coming years there will be an increase in demand for products that can be readily applied to customers' global operational strategies. In other words, we foresee a rise in the need for highly customized products.

Innovation in Motion. With an eye on future trends and lifestyles, we are committed to taking on the challenge of technical innovation. Based on our brand message, which incorporates that commitment and is shared by all Group members around the world, the Tsubaki Group provides solid support for the global business activities of its customers. You can count on Tsubaki.

Tsubaki Mission Statement

Our Mission

We will provide the best value to customers around the world by capitalizing on our technical strengths in power transmission products and materials handling systems.

Our Vision

We aim to be a leading company in the global market for our products.



Global Network

The Tsubaki Group includes 28 production locations and 35 group companies worldwide. Our production and sales networks are more fully developed than ever.

Global Alliances

We continue to aggressively pursue operational alliances, mergers, and technical alliances with companies in Japan and throughout the world.

TSUBAKI Global Business

Best Source/ Best Supply

Through global development of our network, we constantly seek the best combination of regions based on product distribution and market feedback.

Global Marketing

With a keen grasp on the needs of customers, we use the Group's comprehensive strengths to commercialize products rapidly.



Product Line-up

Products to Match Your Needs

From power transmission to materials handling,
Tsubaki products started as our solution to your needs.

Tsubaki's parts, units, and systems are all the results of Tsubaki Group's personalized engineering support to solve the needs of our customers. While protecting the environment is a growing concern, our customers also face problems such as computerization, speeding up operations, and lowering costs. The Tsubaki Group is here to provide the best solutions to these problems through cutting edge engineering and system development capabilities.

Chain

- Drive Chain
- Small Size Conveyor Chain
- Large Size Conveyor Chain
- Top Chain
- Sprockets
- Cable/Hose Protection Systems
- Timing Belts and Pulleys



Drive Chain

Power Transmission Equipment

- Reducers & Variable Speed Drives
- Linear Actuators
- Fasteners
- Couplings
- Clutches
- Overload Protection Units



Reducers & Variable Speed Drives

Material Handling

- Distribution Systems
- Pharmaceutical Systems
- Newspaper Printing Systems
- Other Conveyance, Sorting, and Storage Systems
- Modular Conveyors
- Bulk Handling Systems
- Metalworking Chip and Coolant Processing Conveyors



Linisort®

Global Industrial Steel Chain Market Share*

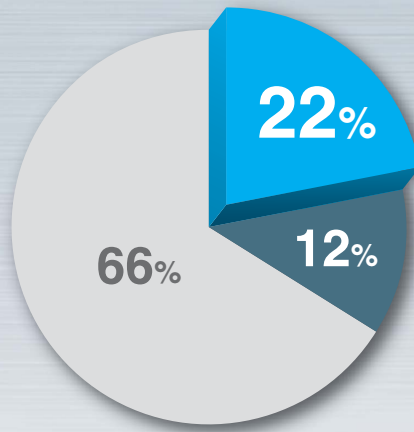

- Tsubaki
- Co. A (England)
- Others

*Based on Tsubaki data

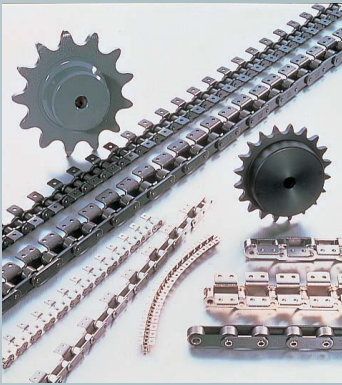

Small Size Conveyor Chain

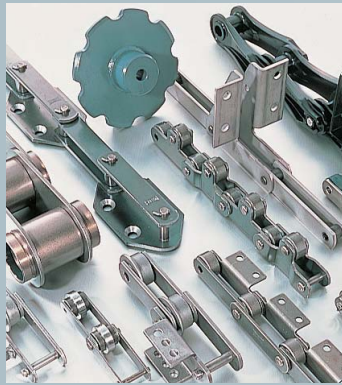

Large Size Conveyor Chain

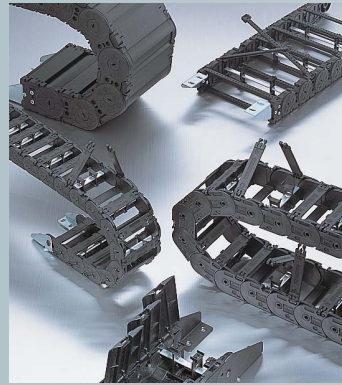

Cableveyor®



Sprockets



Shock Relay®s

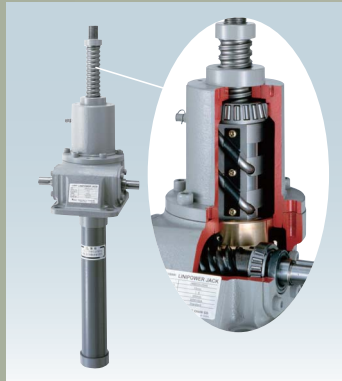

Lini Power Jack



Power Cylinders



Cam Clutches



Conveyance System for Automobile Painting Lines



Zip Chain Lifter®



Coolant/Metalworking Chip Conveyor

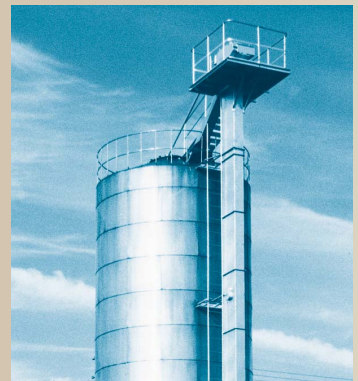

Bucket Elevator

Tsubaki Global Network

The Tsubaki Group's extensive network of production and sales bases supports our customers' businesses in real time around Japan and around the world.

(As of July 2012)



- Global Group Company
- Representative Office

Japan (18 locations)



Kyotanabe Plant



Saitama Plant



Kyoto Plant



Hyogo Plant



Okayama Plant



TMF Plant



North & South America (6 locations)

Asia & Oceania (23 locations)



U.S. Tsubaki, Holdings, Inc.



U.S. Tsubaki Power Transmission, LLC.

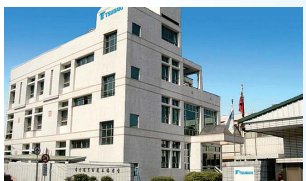

Taiwan Tsubakimoto Co.



Tsubakimoto Singapore Pte. Ltd.



U.S. Tsubaki Automotive, LLC.



Tsubaki of Canada Limited



Tsubakimoto Automotive (Thailand) Co., Ltd.



Tsubaki Australia Pty Ltd

Europe (10 locations)



Tsubakimoto Automotive (Shanghai) Co., Ltd.



Tsubakimoto Chain (Tianjin) Co., Ltd. Full-scale production planned from December 2012.



Tsubakimoto Europe B.V.



Tsubaki Kabelschlepp GmbH

Tsubaki – Serving the Steel



Industry

Making steel is a complex process. You'll find Tsubaki products used throughout the steel mill, from offloading iron ore and coal from tankers to shipping coil steel products. Since 1917, Tsubaki has been using its accumulated know-how, quality, and technical expertise to help steelmakers and equipment manufacturers build the world.



Coking Plant

5 Product Yard

p29

4-2 Cold Mill

p24

1 Stockyard

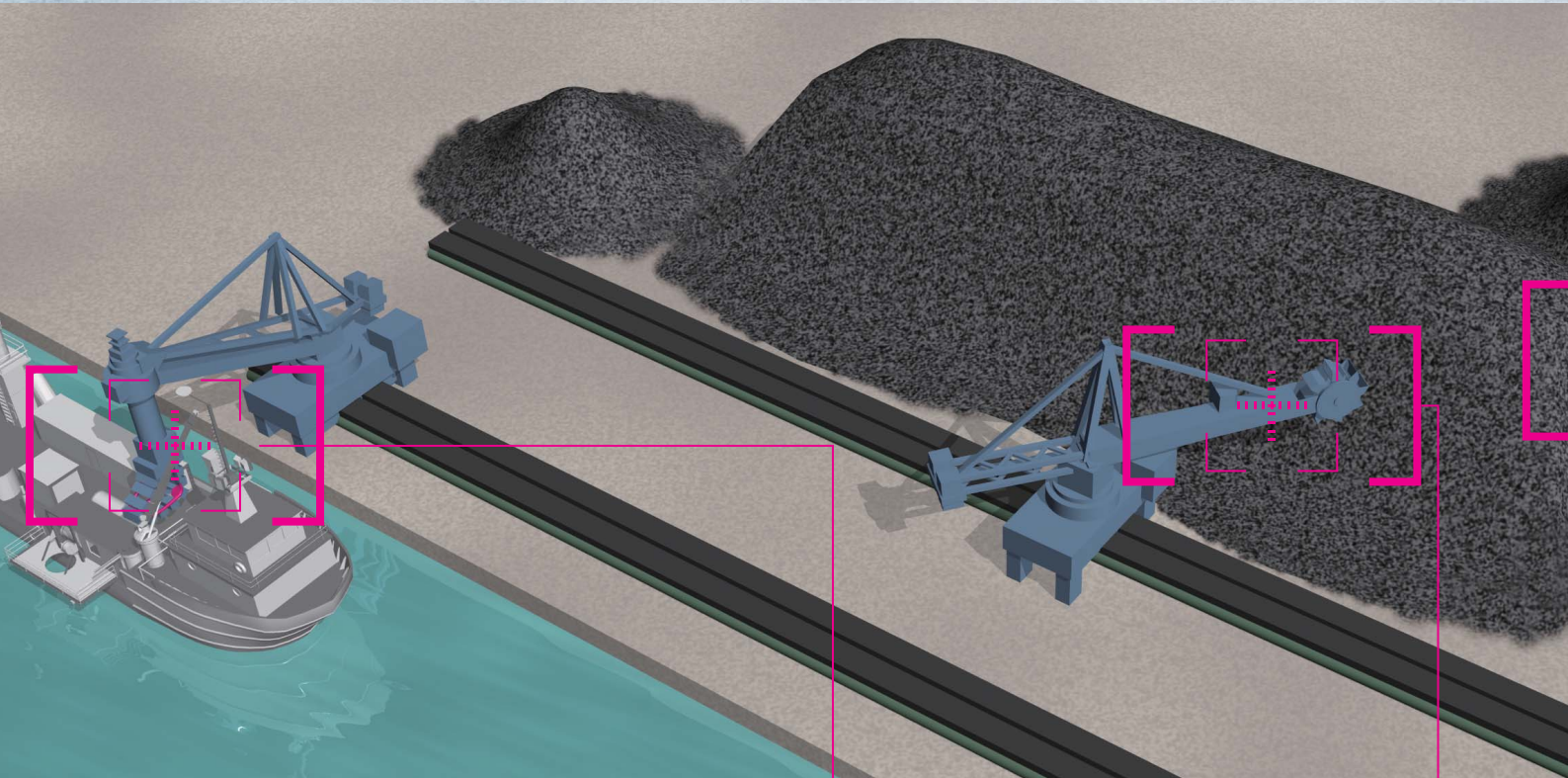

Trust
Tsubaki!

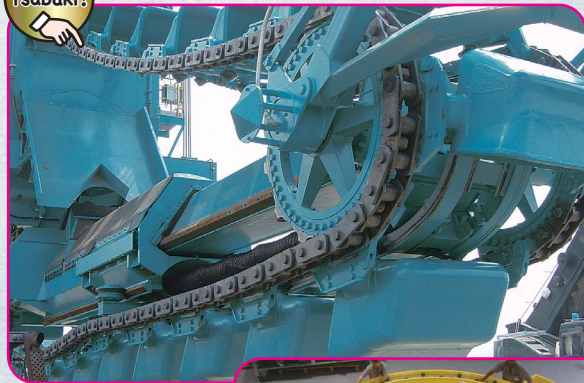

Trust
Tsubaki!

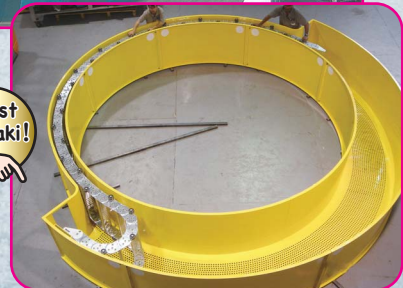

Continuous Unloaders

An unloader uses a bucket to unload coal, iron ore, and other loose material from a tanker. A continuous unloader can unload even more efficiently and in a shorter time, meaning much lower landing costs.

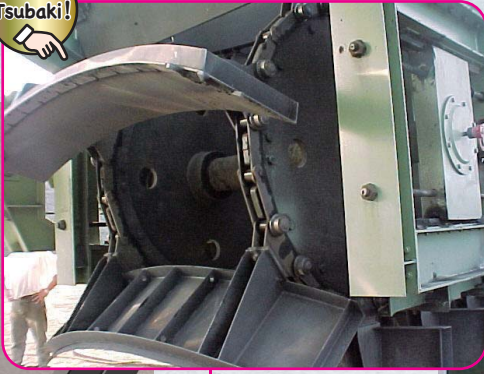

Chain Scraper Reclaimers

A reclaimer reclaims ore and other loose material stored in the stockpile. The shoveled material is then fed to the next process. Reclaimer types include chain scrapers and bucket wheel reclaimers.

p13~14

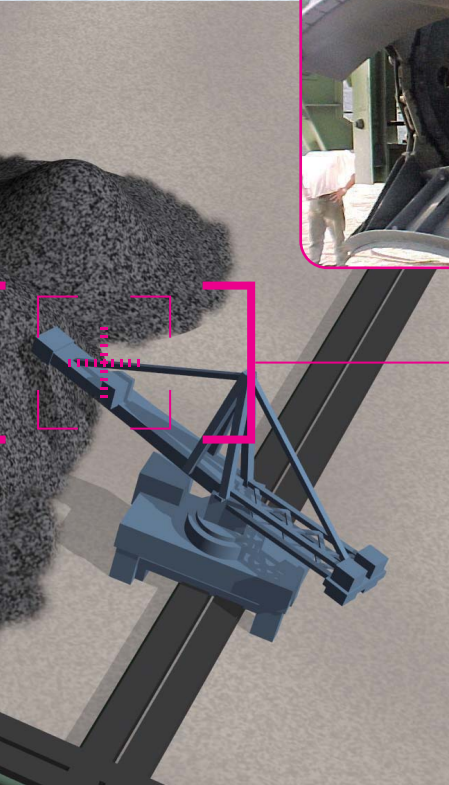

Bucket Wheel Reclaimers

Bucket wheel reclaimers feature buckets attached to a wheel at the end of a boom. The wheel rotates and feeds material from the stockpile to the next process

p13~14



1 Stockyard



Continuous Unloader

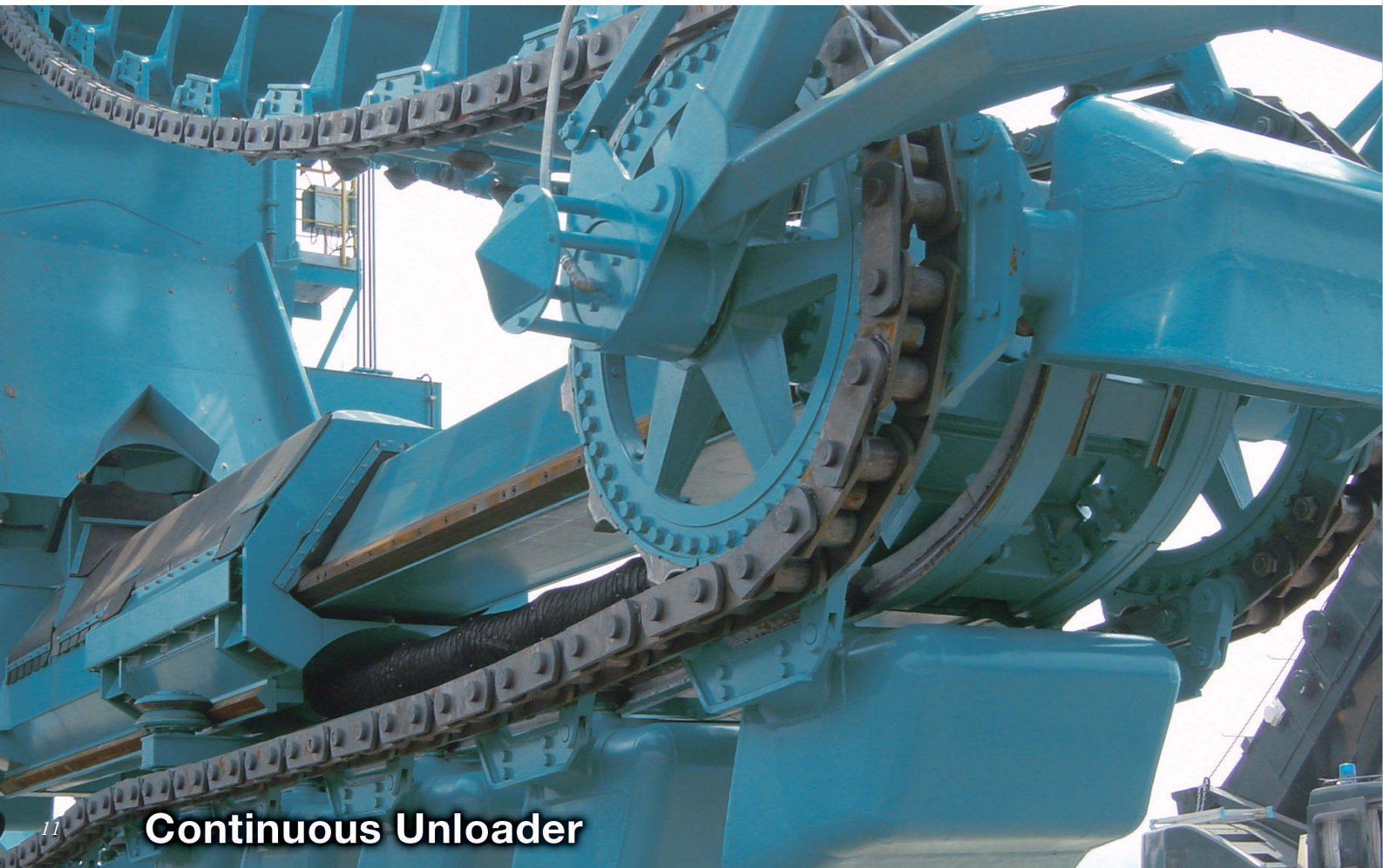

Continuous Unloader

Unloader Chain



Unique technology gives Tsubaki Unloader Chain its superb endurance and proven track record. We also offer various specifications and series to match the needs of the conveyed items.



Unloader Sprockets



Unloader sprockets are optimized for use with unloader chains. We specially harden them for extremely effective wear resistance.

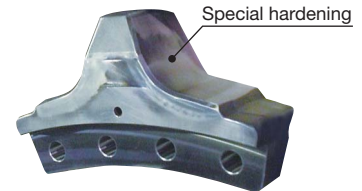

Steel Cable Carrier Systems



TK / S / SX Series

Steel Cableveyor® has excellent strength and heat resistance. Stainless steel and side mount specifications are also available. We also offer an extensive line-up of tube type Cableveyors for added cable/hose protection.



Side mount specifications

Helical Reducers

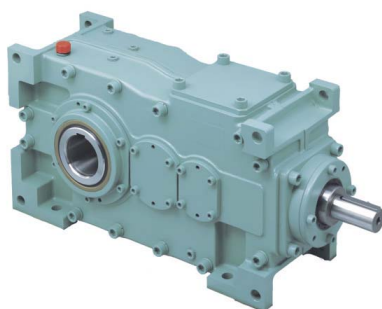

● Helical Power Drive

Highly reliable Tsubaki Helical Power Drive series helical reducers are often used in crane travel and swiveling sections.

Crane travel drive

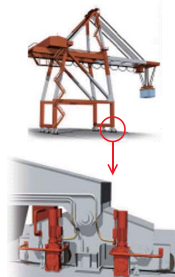

1 Stockyard



Chain Scraper Reclaimer



Bucket Wheel Reclaimer

Reclaimer Chain



When abrasive material infiltrates between bushes and rollers, and infiltrates outboard rollers, the rollers lock and wear accelerates between bush and roller, causing your chain to reach its wear life.

Using Tsubaki's dust resistant bearing rollers can extend the life of your reclaimer chain.

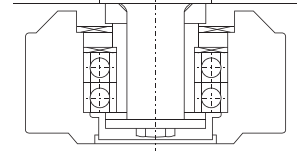

Sample outboard roller seal construction
(over 15,000hrs proven performance)

Heavy Duty Roller Chain



Tsubaki Heavy Duty Roller Chains provide proven performance even on amusement rides.

The optimal material and perfect heat treatment give Tsubaki Heavy Duty Roller Chains unparalleled tensile strength and shock resistance.

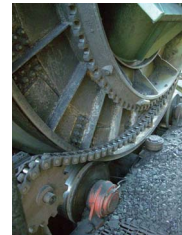

Heavy Duty Roller Chain
on a reclaimer drive

Power-Lock®



Power-Locks are friction-type fastening devices that simply and securely fasten to shafts and bosses for no backlash. You will find just the right type for your needs from our extensive line-up and multiple sizes.



Roller Chain Couplings



These are flexible couplings made with two solid coupling-tailored roller chains wrapped around two sprockets. Used in standard drive situations.



2 Pig Iron Plant

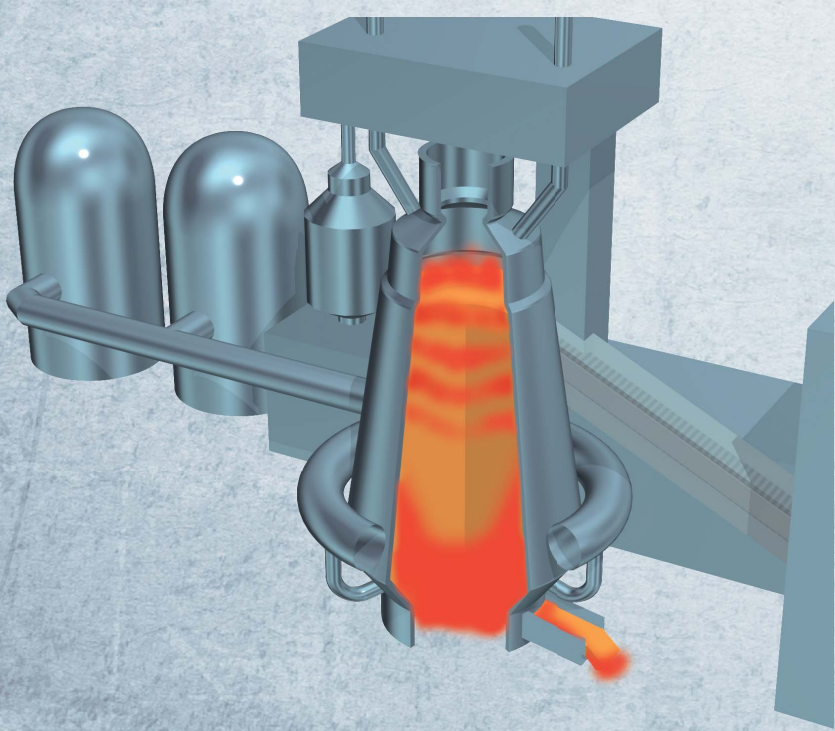
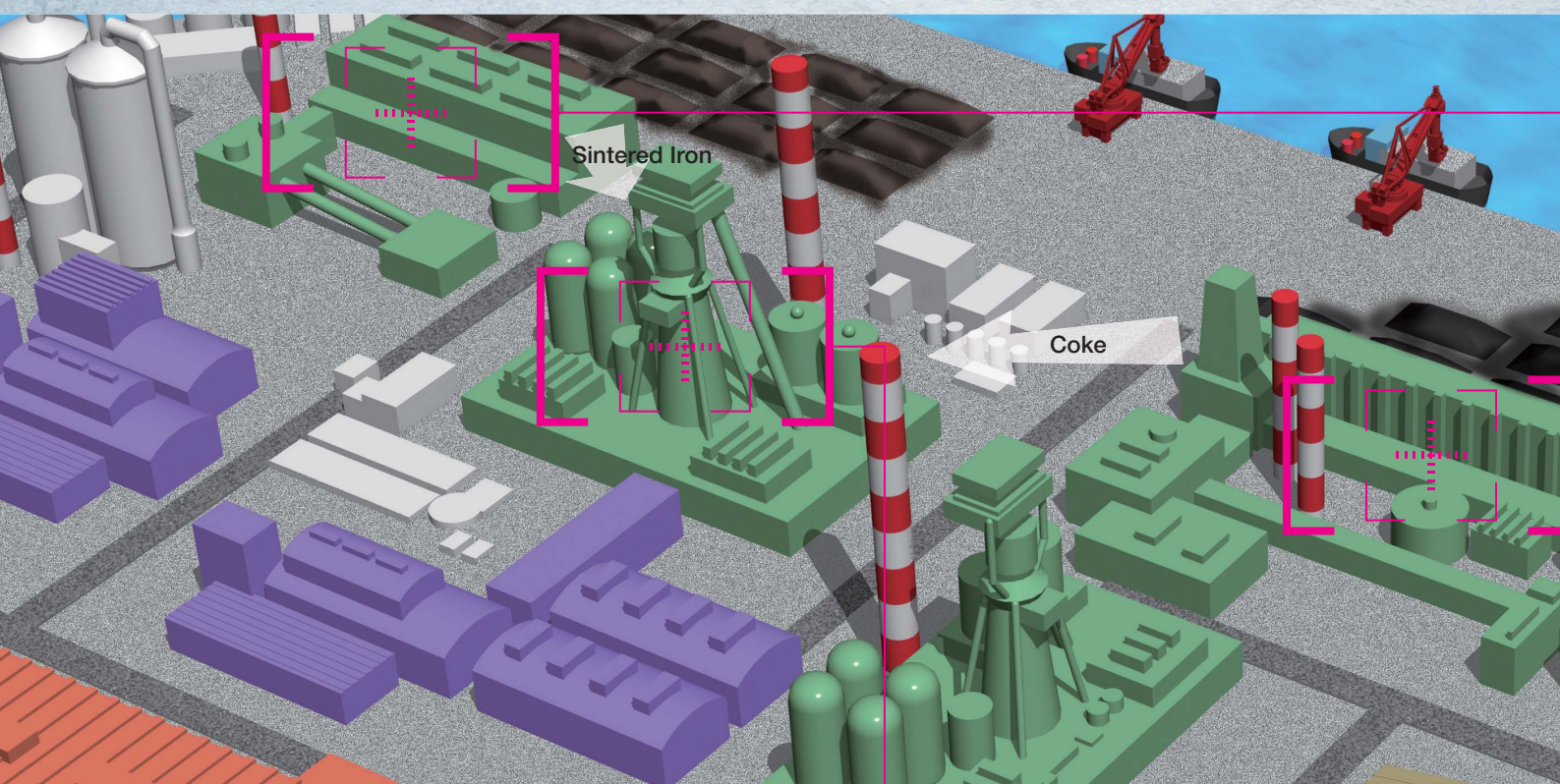

● *Blast Furnace*

Here, iron is created from iron ore. Iron ore and coke are alternately charged in the furnace from the top, while hot air is pumped in from below. The CO₂ generated from the burning of coke reduces the iron ore to iron. Temperatures inside the furnace can reach 2000°C. The melted iron (hot metal) is removed from beneath the furnace.

Sintering Plant

Coking Plant

Blast Furnace



Stockyard

Pig Iron Plant

Steel Mill

Hot Strip Mill and Cold Mill

Product Yard

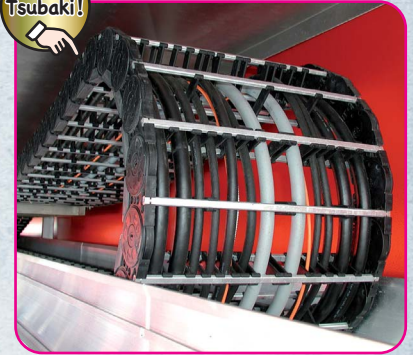
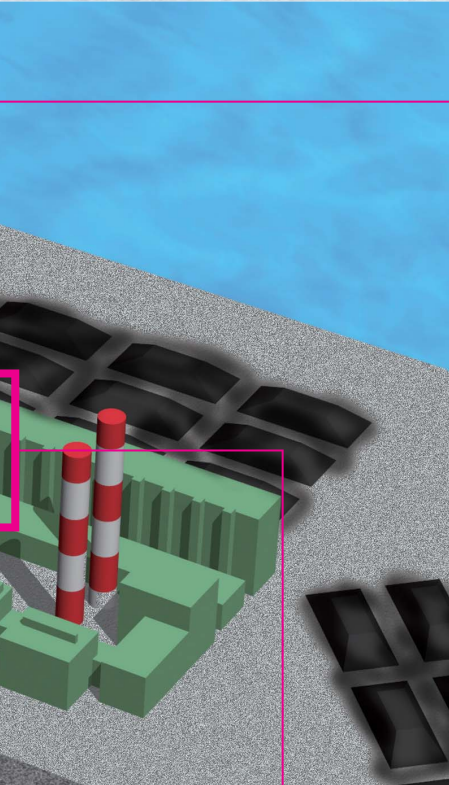

Sintering Plant

In the sintering process, powdered iron ore, which makes up the majority of imported iron ore, is fused to create sintered ore.

p17~18



Coking Plant

Coal in the furnace is distilled to manufacture coke. Iron is extracted by reducing iron ore in the presence of carbon, with also becomes a source of heat for melting ore and limestone.

p17~18

2 Pig Iron Plant



Apron Conveyor Drive



Sintered Ore Apron Conveyor



Sintering Gas Treatment Equipment

RS® Roller Chain G7-EX

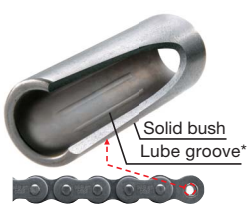

Tsubaki's standard RS Roller Chain G7-EX uses a seamless solid bush developed through unique Tsubaki engineering and processing. The special lube grooves* in our high precision solid bushes retain lubrication longer for twice the chain wear life.
*Lube grooves available for RS80 – RS140 only.

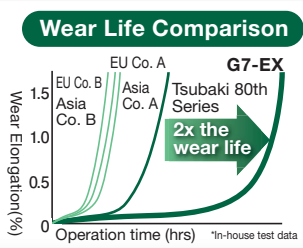

Drive Sprockets



We ensure that our Tsubaki roller chain sprockets have a deep hardened layer over the entire sprocket – even the teeth bottoms. This ensures superb wear life for teeth bottoms and long life for the sprocket. We offer an extensive line-up of sprockets with a wide-ranging number of teeth, rows, and shapes, as well as finished bore sprockets and bore fasteners.

Comparison of Hardened Layers



Power Cylinders



Tsubaki Power Cylinders are electric cylinders that can operate with just simple wiring. With no troublesome hydraulic or pneumatic pipes to worry about, maintenance is a snap. Standardized operation for small to large thrust forces, diverse options, and various built-in overload safety devices built-in give our users peace of mind. Highly efficient ball screws provide long service life even under high speed/high frequency use.



Hybrid Cable Carrier System

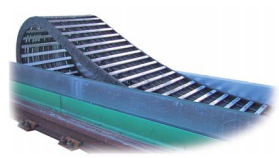

Hybrid cable carrier systems (sideband made of plastic and stays made of aluminum) are available in 1mm width increments to perfectly fit to the available mounting space. When operating on crane systems, the carriers run safely in guide channels made of steel sheet metal which are custom-made for any application. In doing so, we can accommodate almost any request for special shapes and fastening options.



NAB Aprozator



Steel mills are using NAB 600QT Aprozators in their sintering gas treatment equipment. Recent years have seen the development of flue gas treatment technology using activated coke to treat the sulfur oxides, dioxins, and other chemicals found in flue gas. Activated coke is flammable when exposed to air, which is why the sealed Aprozator from Tsubaki Bulk Systems is so widely used. The Aprozator is a bucket-type conveyor that allows for horizontal – vertical – horizontal conveyance in just one unit. The vertical conveyance portion can reach heights over 50m. Put Tsubaki's experience to work for you.



3 Steel Mill

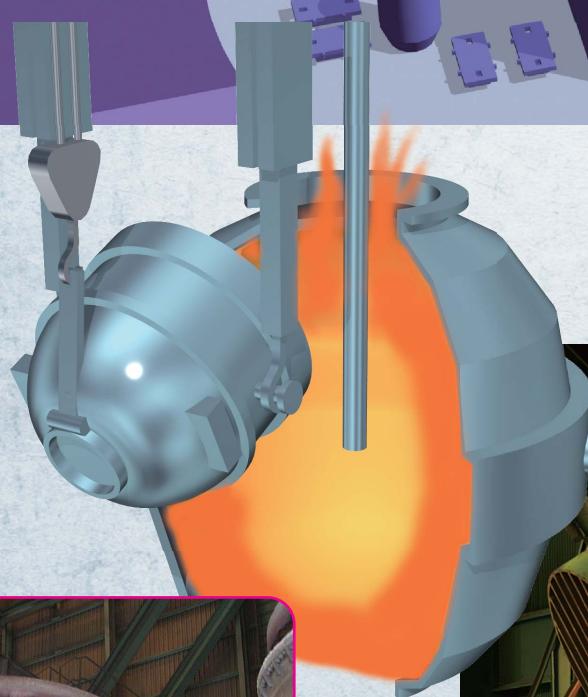
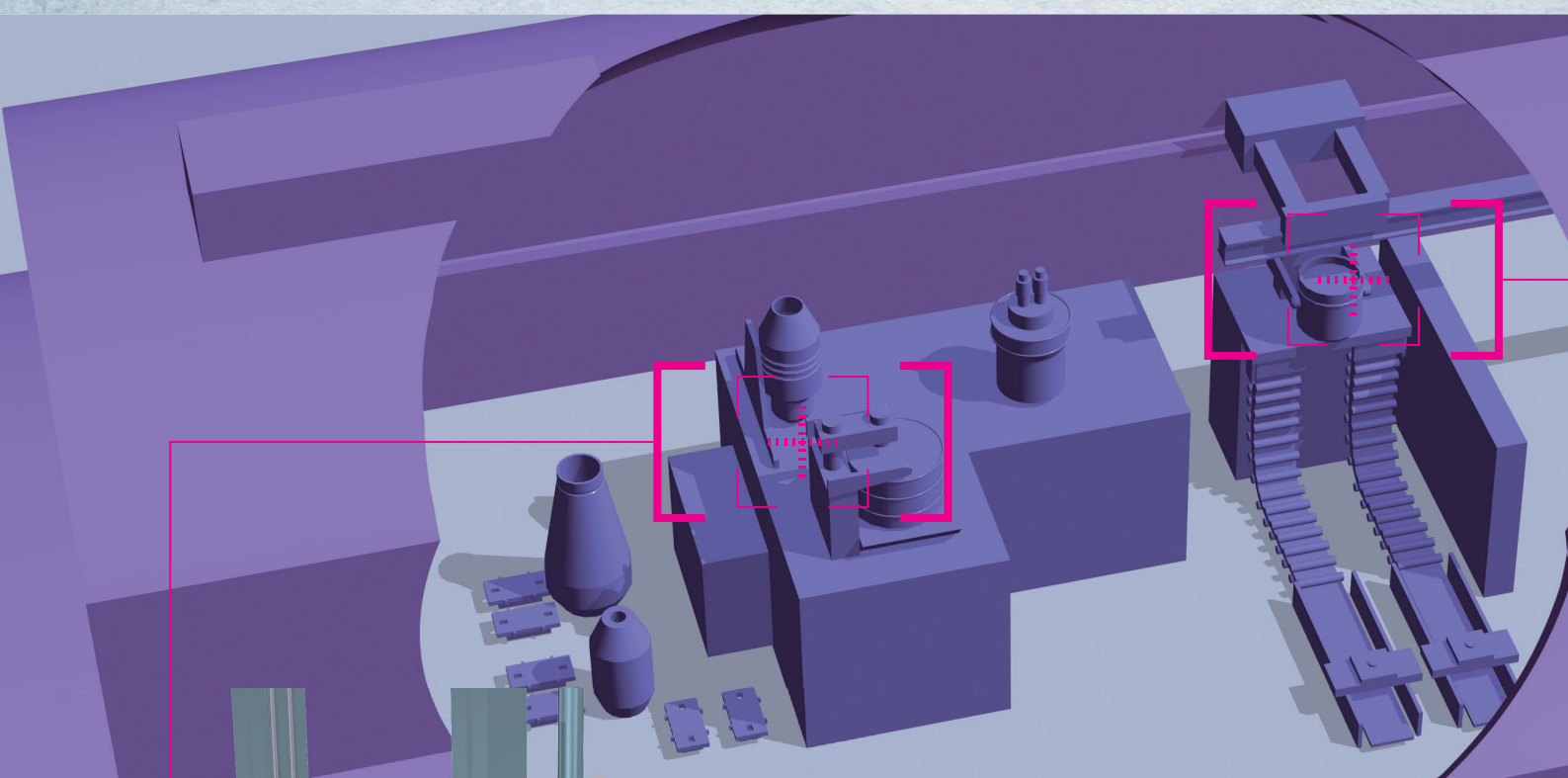

Trust
Tsubaki!



• Converter

Here, the hot metal from the blast furnace is reduced to form molten steel. The hot metal contains carbon, silicon, phosphorus, and many other impurities, so it is transferred to the converter, where oxygen is blown in from above and below to oxidize and remove the impurities. This allows the required optimal components to be adjusted to make steel.

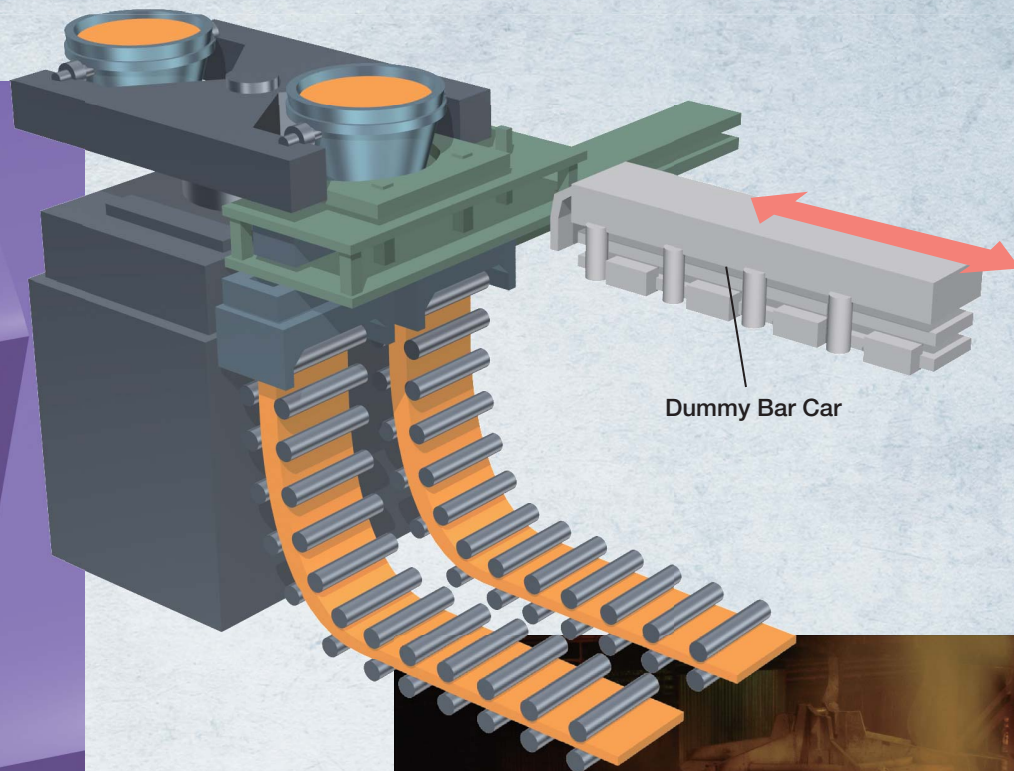

Dummy Bar Car

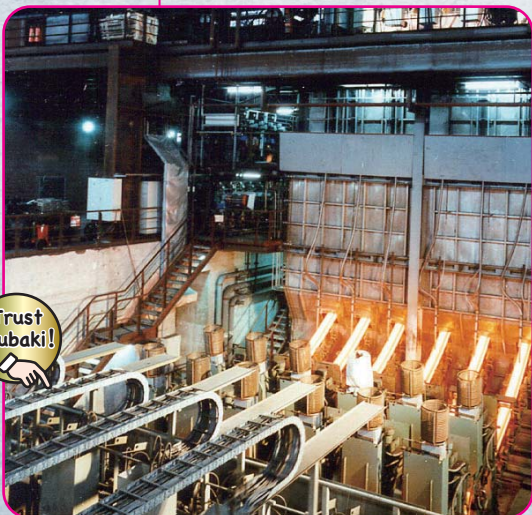

Trust
Tsubaki!

Continuous Casting

Here, the molten steel reduced in the converter is hardened and shaped into billets. The molten steel taken from the converter is continuously poured from the ladle into a mold below and cooled. The cooled, hardened steel is cut to specific lengths and carried to the rolling process to be shaped.

3 Steel Mill



Converter



Continuous Casting

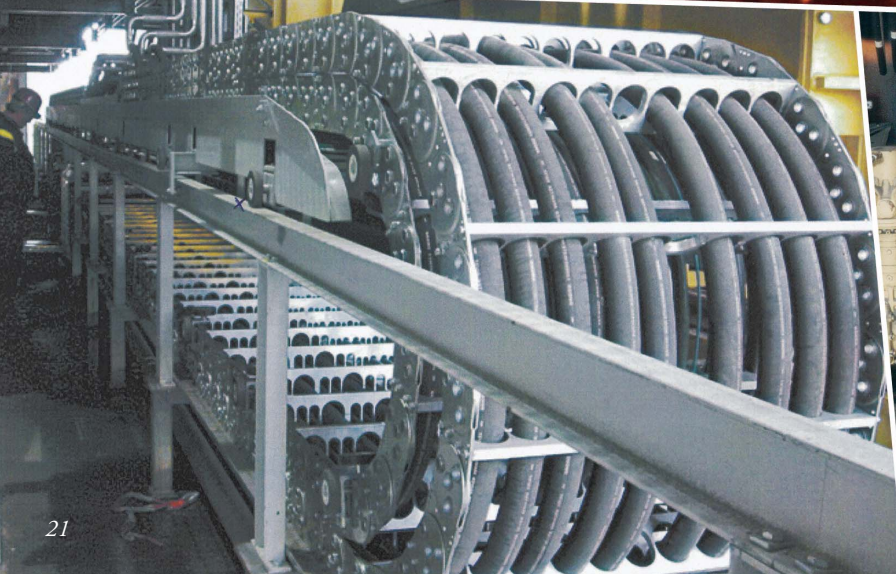

T Series Power Cylinder



The T Series Power Cylinder is a heavy thrust type power cylinder that uses AC power. Tsubaki offers a wide range of models to match any application, thrust, or speed.

Thrust ranges from 2.45 to 313kN{250 to 32000kgf}, with a maximum stroke of 2000mm.

All models use a braked motor for reliable load support and safety. Heat resistant and other special braked motors can be easily installed for high temperature environments.



Dummy Bar Car Chain

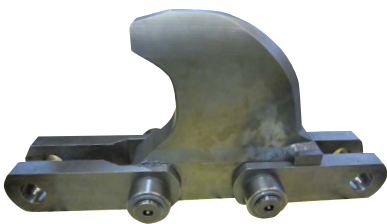

This chain returns dummy bars used in continuous casting to their original position.

The attachments are individually designed to match the customer's dummy bars. The plates and the part of the attachment that engages the dummy bar are quench hardened for added strength.



Dummy Bar Car Chain inside a dummy bar car

TKV/TKI Series Steel Cableveyor® S/SX1252B / 1802B

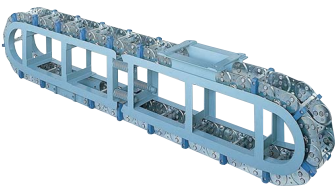

TKV Series

TKV Series Cableveyors have a maximum stroke of 30m (100m for the TKI Series). The maximum travel speed of the TKV Series is 150m/min, and TKI Series 120m/min, so they are usable in high frequency, high speed, and long travel stroke ranges where previous steel Cableveyors were not.



TKI Series



S / SX 1252B / 1802B

The optimized geometry of S/SX 1252B and S/SX 1802B reliably prevent costly downtimes and maintenance breaks for the entire system – especially in environments, where large amounts of very fine, abrasive media are generated. Foreign bodies entering into the system are removed from the stroke system by the self-cleaning effect of the cable carrier in motion.

4 Hot Strip Mill and Cold Mill

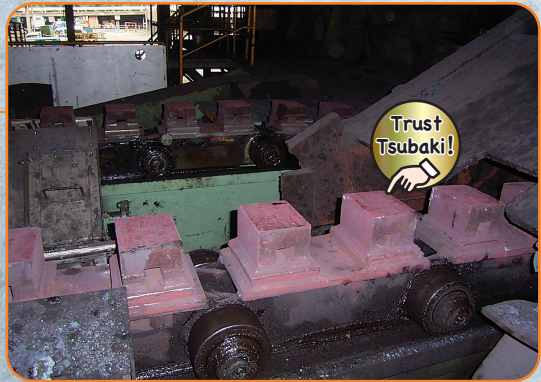
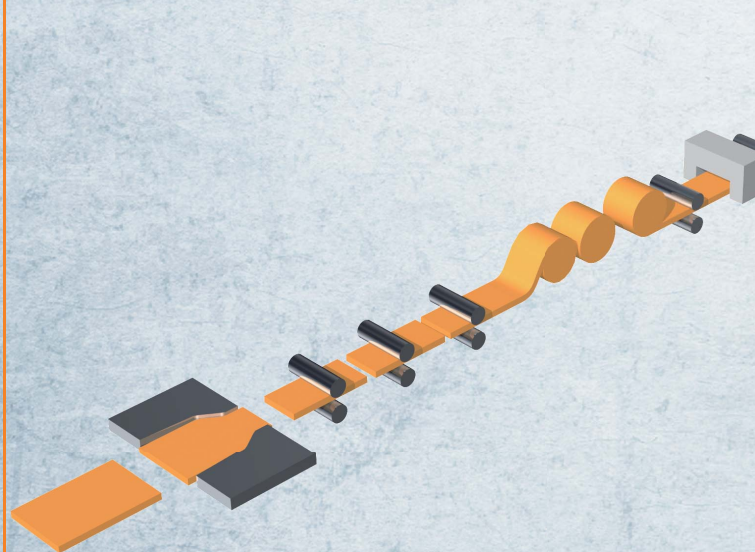
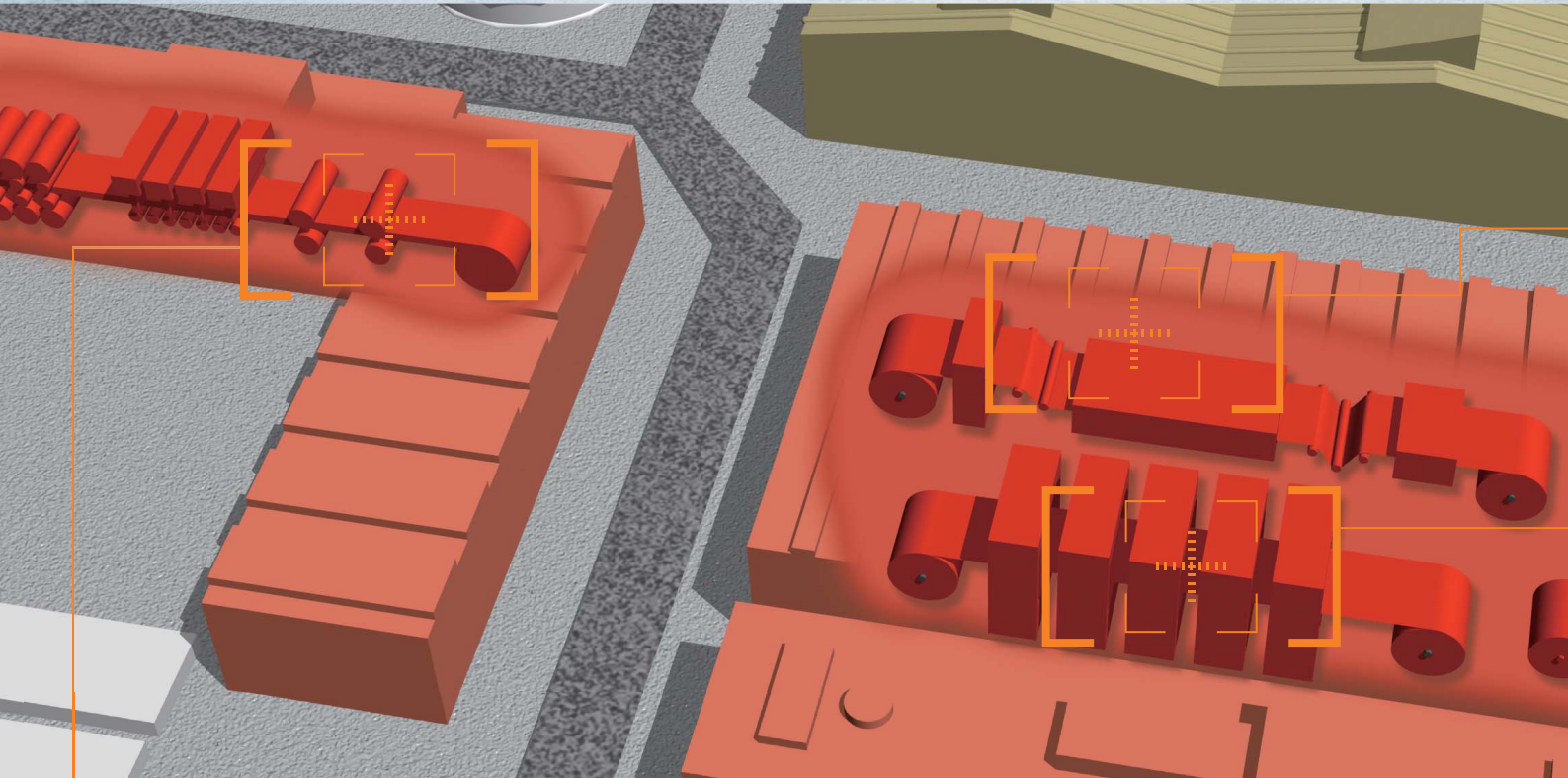

Hot Rolling

Here, slabs are pulled to make steel strips. The slabs are reheated to 1250°C and rolled while hot. The rolled strip steel is then wound up like a roll of toilet paper (called a "hot coil").

p25~26

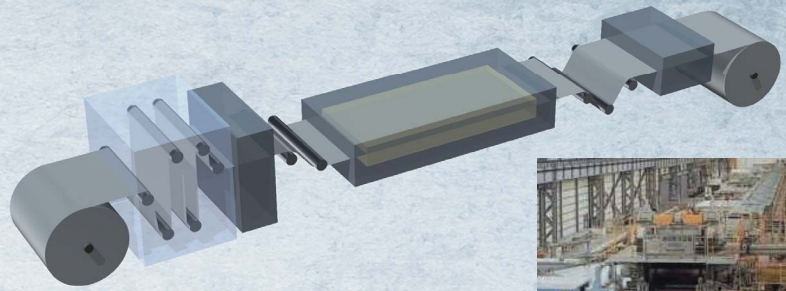

Pickling

The surface scale (iron oxide) formed on hot coils in the hot rolling process are washed off ("pickled") using hydrochloric acid.

p25~26

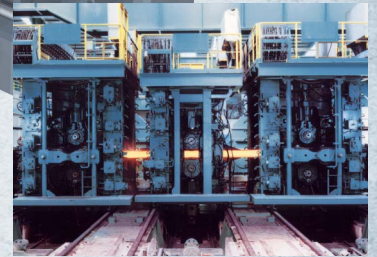
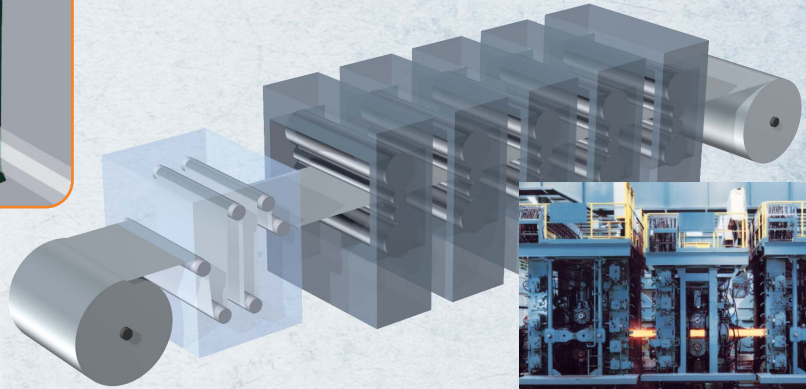
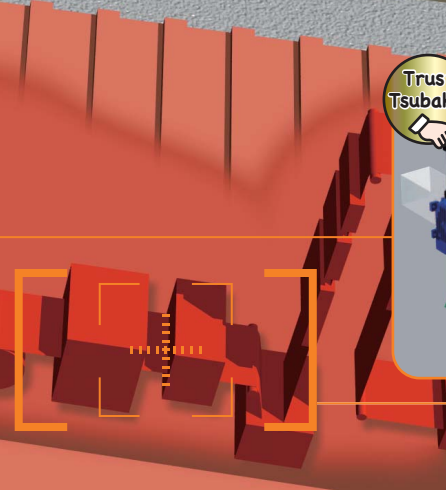
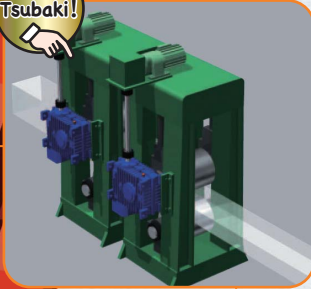

Cold Rolling

Here, hot coils are rolled to a usable thickness at room temperature. Coils rolled even thinner during this process are called cold rolled coils.

p27~28



Zinc Plating

Here, iron is dipped into and coated with molten zinc.

p27~28

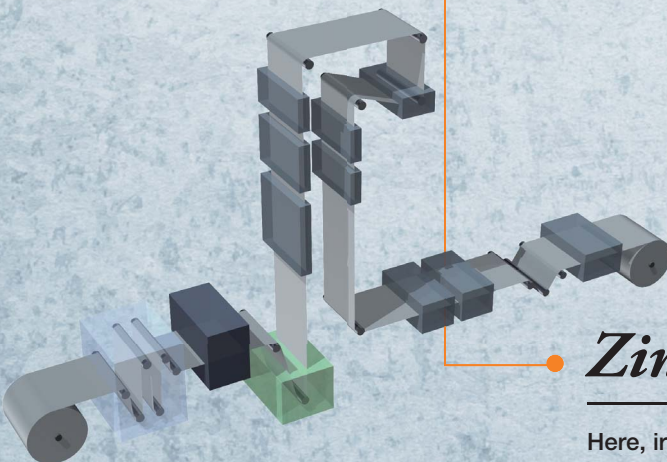

4 Hot Strip Mill and Cold Mill

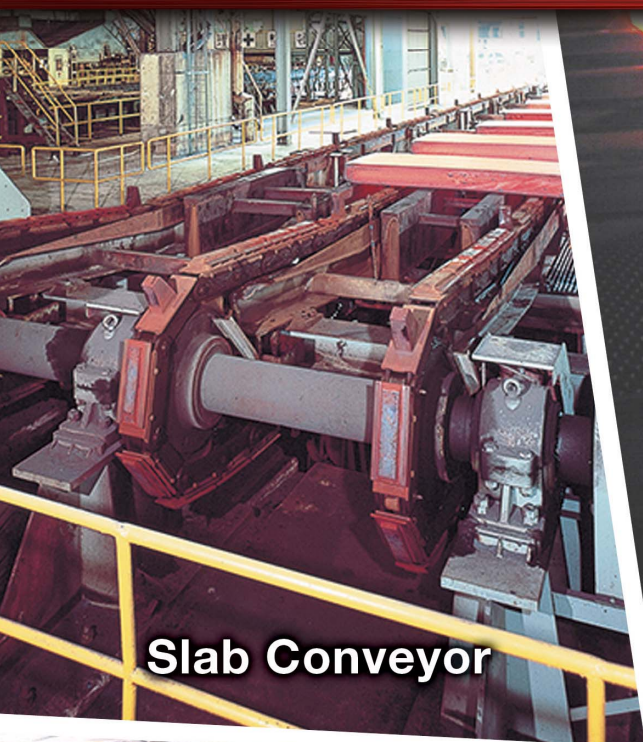

Slab Conveyor

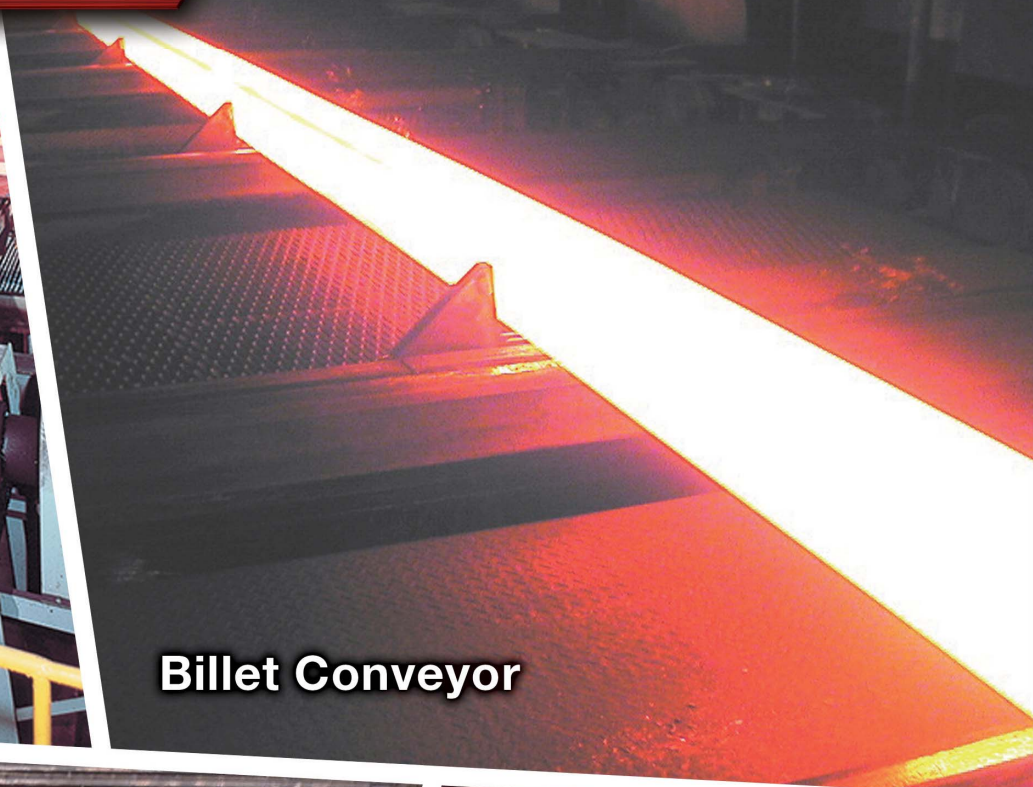

Billet Conveyor



Cooling Bed



Cooling Bed Drive

Semi-finished Product Conveyor Chain



Chains used to convey slabs, billets, and other semi-finished products have to be designed in light of the product's shape and temperature, as well as the conveying environment.

Let Tsubaki's extensive track record help find the right specifications for you.

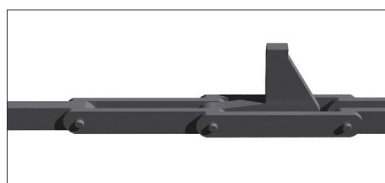

Billet conveyor



Slab conveyor



Slab conveyor



Cooling head



Wire rod conveyor



Wire rod conveyor

NEP Series Roller Chain



Lines subjected to cold water sprays have problems with corrosion. With NEP Series, the pins, bushes, and plates have a unique triple layer coating, and the rollers are also specially coated, for added corrosion resistance.

NEP Chain does not use hexavalent chromium, cadmium, mercury, or arsenic and so is RoHS compliant.

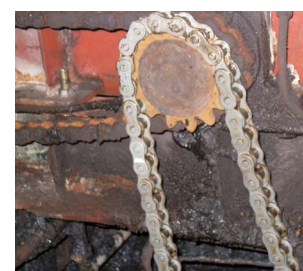

Covered Cable Carrier Systems



Cover system RMD

Covered or closed steel cable carrier systems should be used for applications where hot chips or severe contamination occur. The cover system also protects the layed cables against short-term radiant heat impact. Available as covered types with the robust Covered system RMD or economically priced, light covered types (steel band cover) for flying sparks and small chips.



Steel band cover

4 Hot Strip Mill and Cold Mill

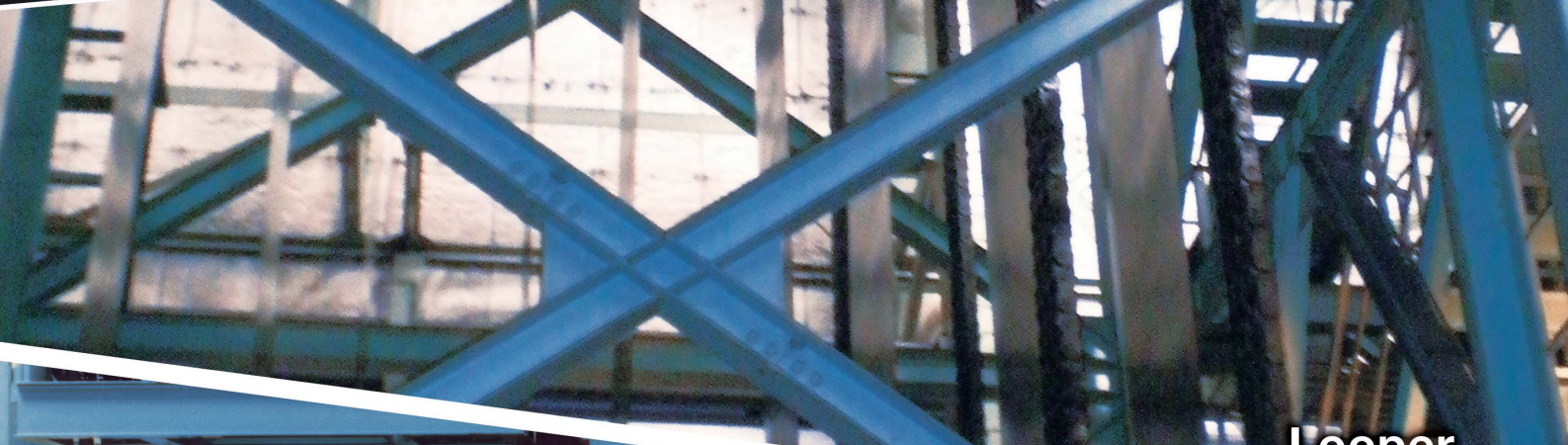

Looper

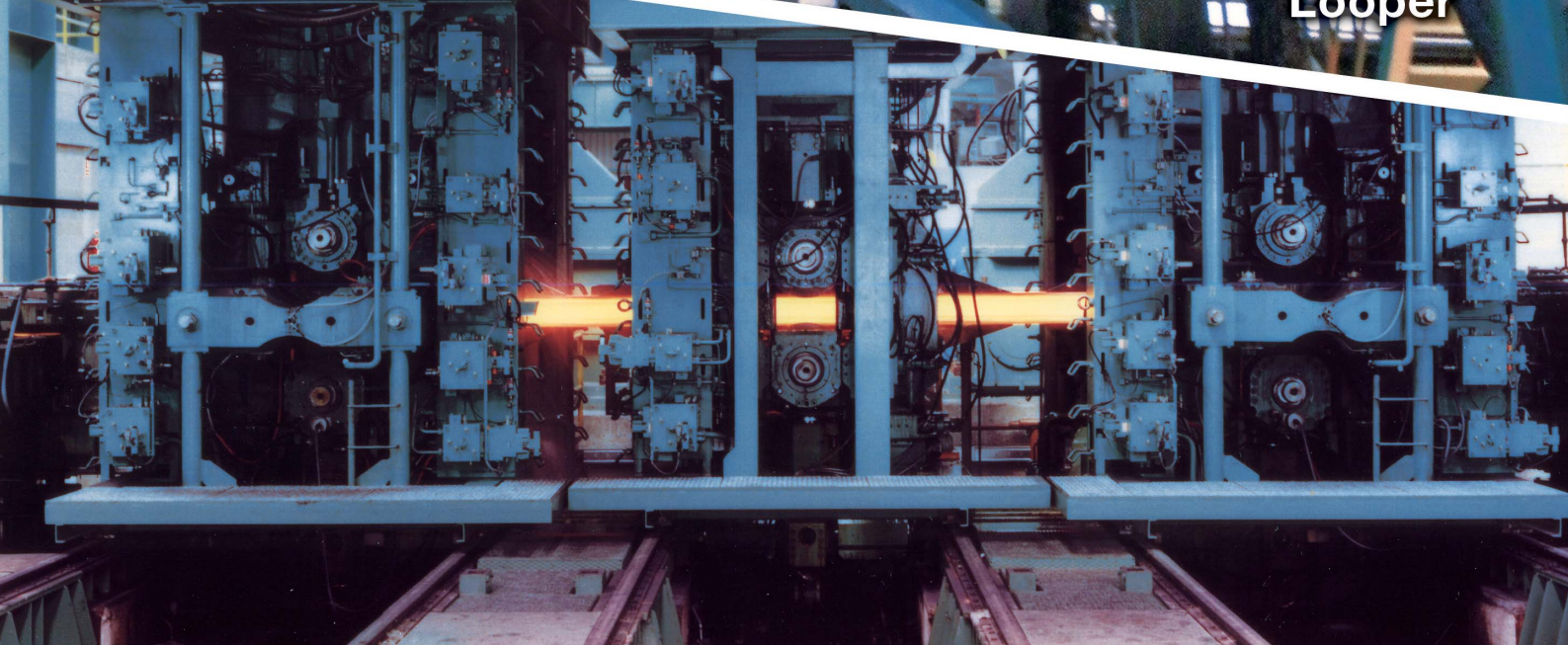

Rolling Mill

Heavy Duty Roller Chain

The shape and thickness of heavy duty roller chain link plates are larger, allowing for more compact designs, excellent kilowatt ratings, and higher allowable load and tensile strength.



Minimum Tensile Strength & Maximum Allowable Load Comparison

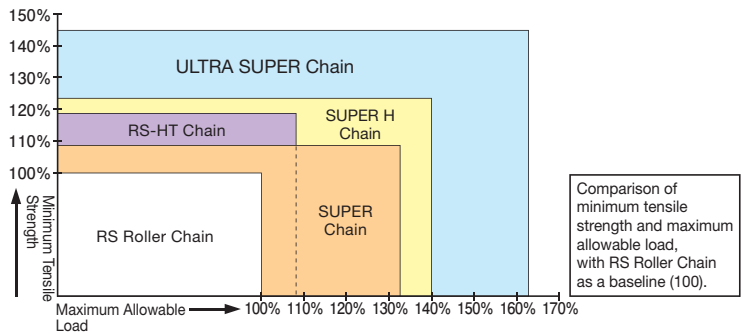

● SUPER Chain

We've adjusted the size of the plate waist to give the chain 30% greater maximum allowable load over standard Roller Chain.

● RS-HT Chain

By increasing the thickness of the plate, we've increased this chain's tensile strength by 20% over standard roller chain over standard Roller Chain.

● SUPER H Chain

SUPER H Chain has the same shape as SUPER Chain, but with a thicker plate. Ideal for applications requiring a higher allowable load, tensile strength, and shock absorption.

● ULTRA SUPER Chain

The plates are oval and thicker than SUPER H Chain plates for the highest level of allowable load, tensile strength, and shock absorption for more compact designs.

Worm Reducers

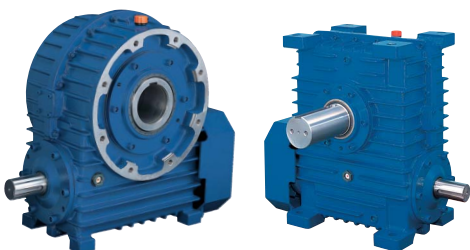

● Troi Drive® Worm Power Drive®

Rolling mills use Troi Drives, drum shaped gears that have a high load capacity.

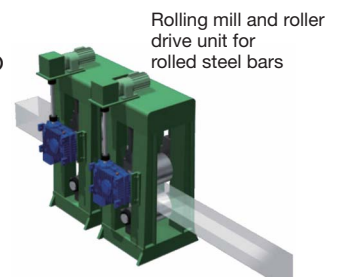

5 Product Yard

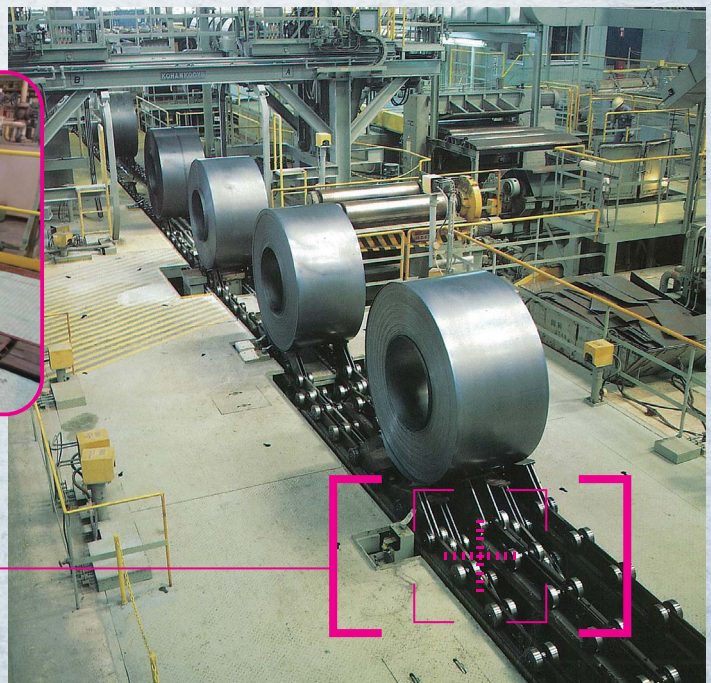
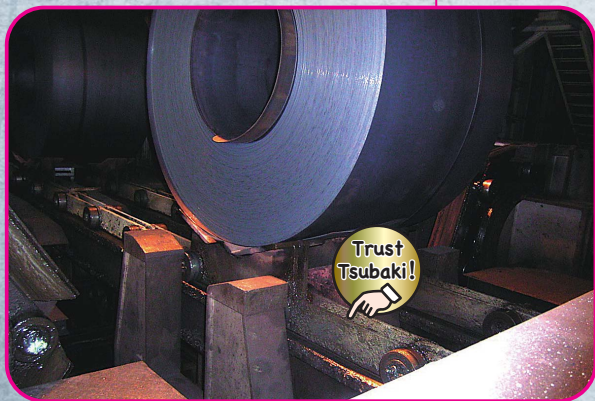
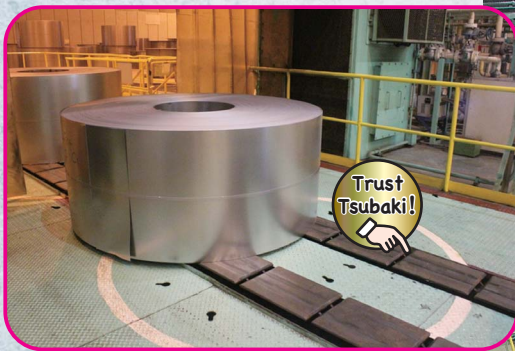
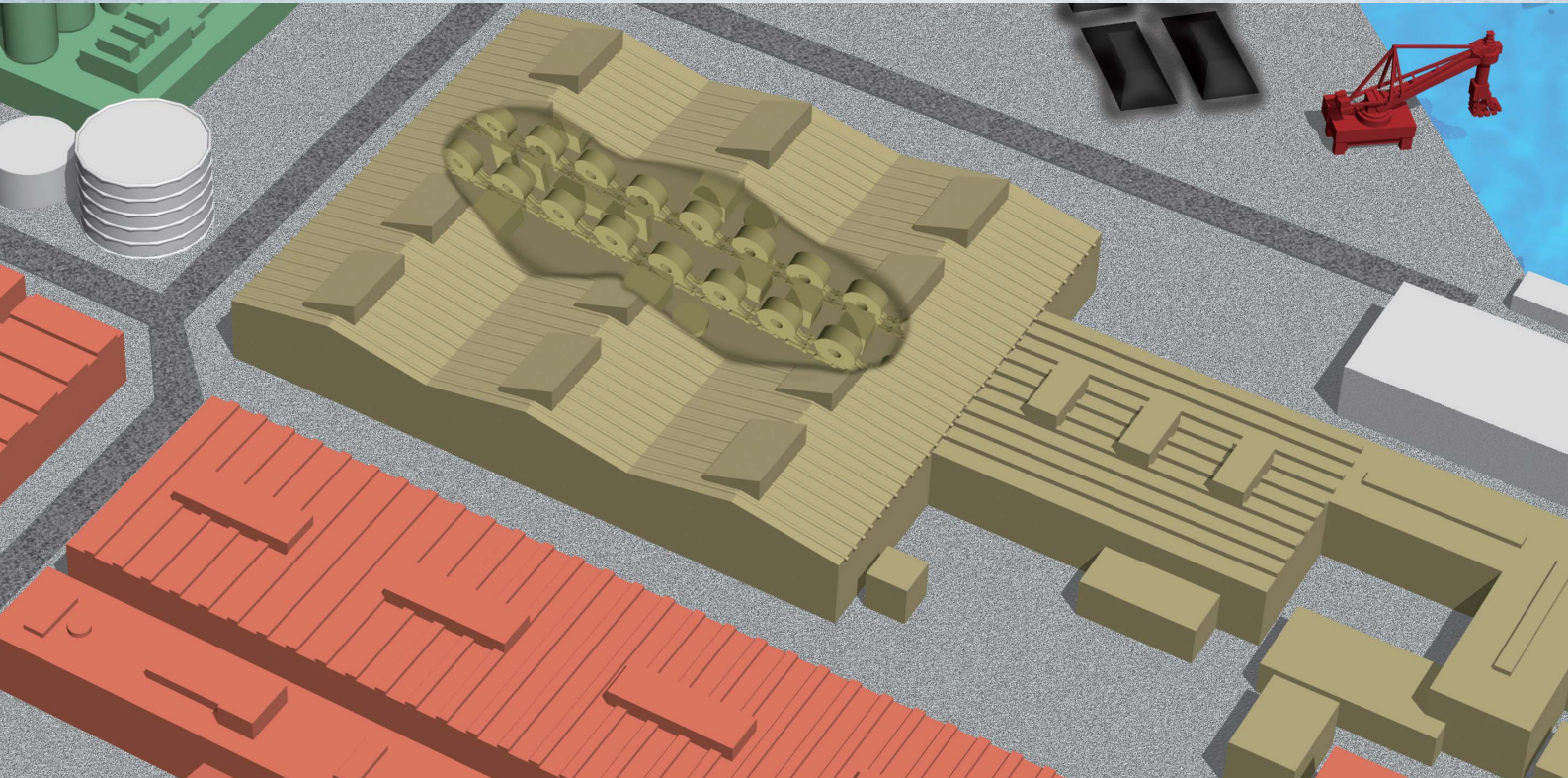

• Coil Conveyor

A coil conveyor runs between the equipment upstream and downstream of the hot rolling, pickling, and cold rolling lines, the temporary storage area for coils needing production adjustment, and between various other lines. The conveyor must convey efficiently to meet production schedules.

P31~32

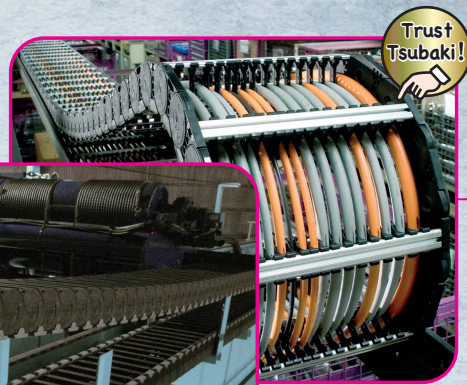
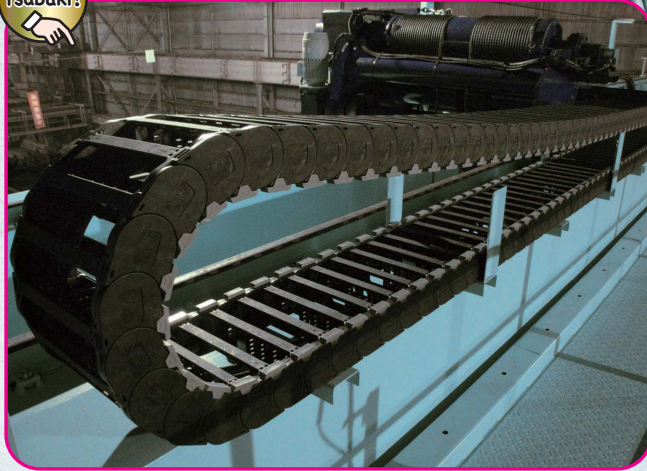

• Ceiling Crane

Ceiling cranes can hoist, move laterally, and more backwards and forwards. They provide reliable performance in a wide range of work areas, and are often used in conveying coils in the storage yard, product shipping yard, and so on.

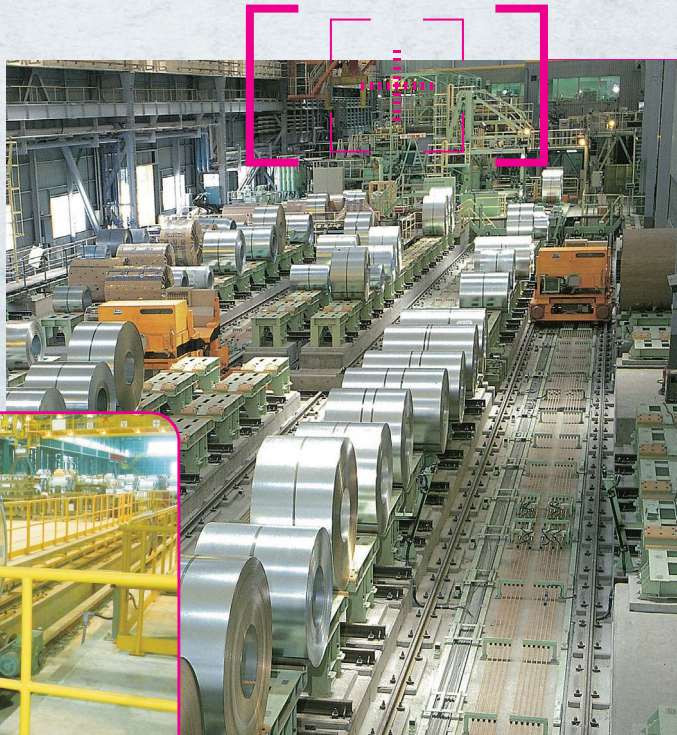

p31~32

• Pallet Car

There are many coil transfer systems in the coil storage yard and shipping yard.

p31~32

5 Product Yard

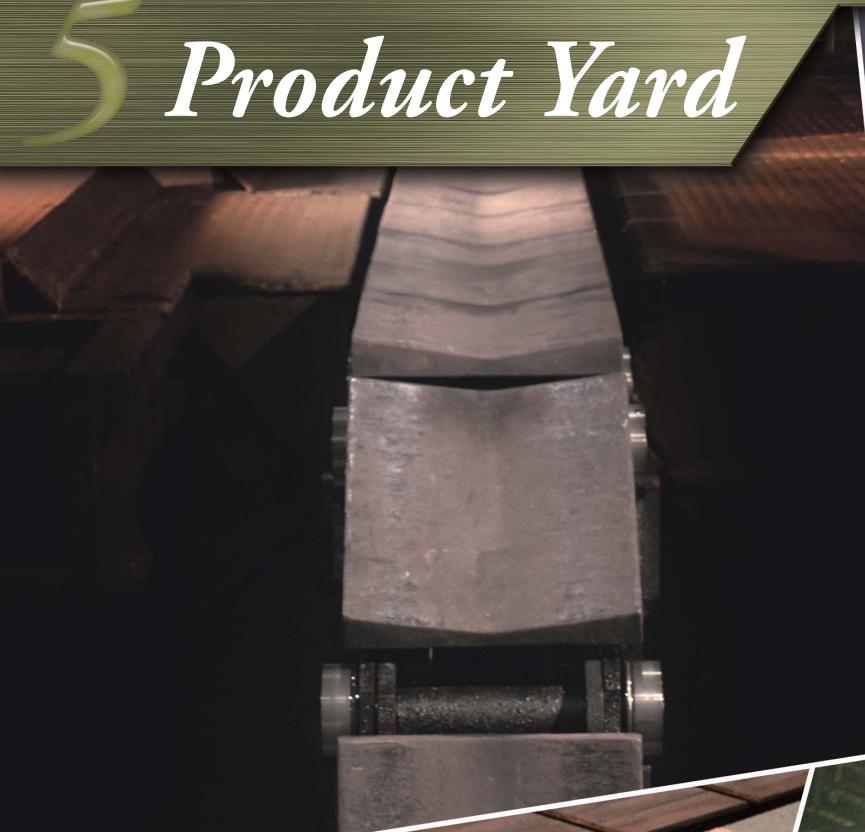

Coil Conveyor



Scrap Conveyor



Coil Conveyor Chain



Coil Conveyor Chains use our unique bearing rollers to reduce running resistance. (Coefficient of friction = 0.03)
The roller is also designed to be extremely resistant to cracking, and we manufacture the saddle to match your conveyor design.



Bearing Roller Conveyor Chain



Previous Series

A unique Tsubaki roller that features cylindrical bearings inside the roller itself. Our line-up includes dust-resistant, water-resistant, and lube-free series chains.

Standard Conveyor Chain



Bearing Roller Conveyor Chain



Bearing roller functions

1. Reduce the chain running resistance (1/3 that of standard conveyor chain)
2. Greatly increase the roller allowable load

Bearing roller effects

1. Reduced chain tension and required drive.
2. Eliminates stick-slip phenomenon on long lines and low speed operation
3. Suppresses poor roller rotation and reduces rail friction
4. Increased wear life (between bush - roller)

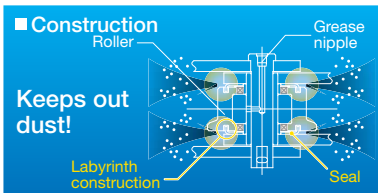

Dust Resistant Series

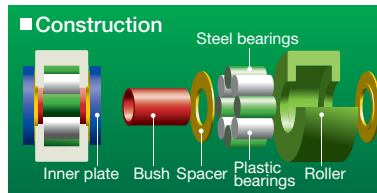

Standard Lube-free Series

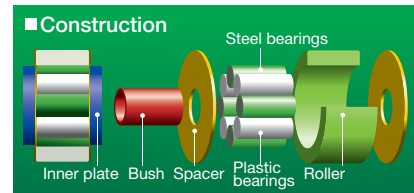

Water-resistant Series

Shuffle Conveyor



Shuffle Conveyors are a new type of conveyor that use a repeat back-and-forth motion to convey material. Unlike vibrating conveyors, Shuffle Conveyors are quiet during operation, and their simple construction makes maintenance easy. And unlike belt conveyors there is no way for conveyed goods to be returned.



5 Product Yard



Coil Robot System

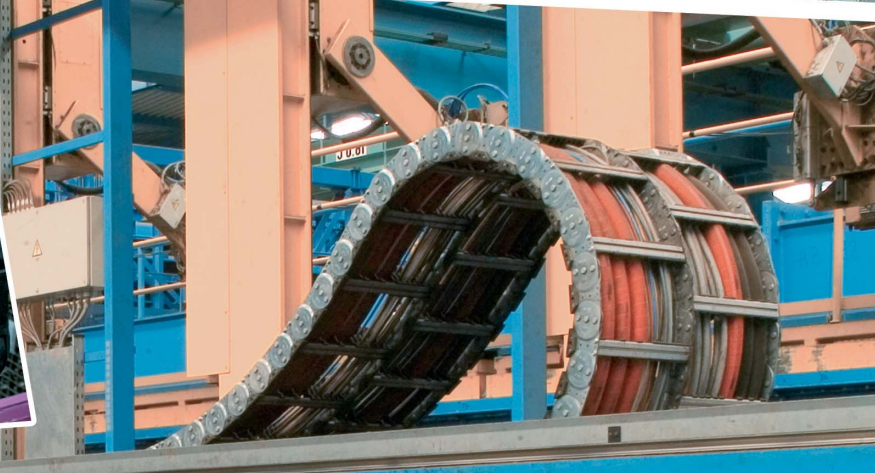
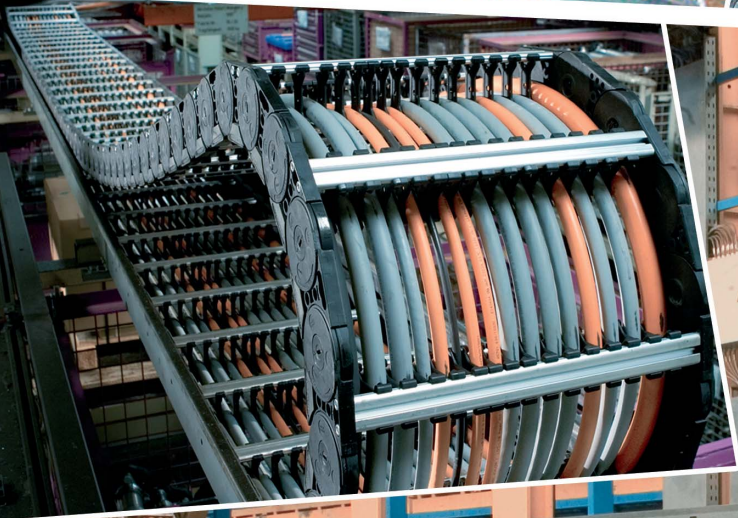

Ceiling Crane

Coil Robot System



Bi-level Transfer Car

There are many automated coil storage and retrieval systems operating in the hot/cold rolled coil temporary storage yard and product management area of the shipping yard.

Tsubaki Mayfran, Inc., with its proven performance in the field, works together with customers to provide the safe operation and increased productivity they need.



Pallet Car



Coil Packing Line



Coil Turner



Storage Robot



Liner Robot



Skid Robot



Shuttle Robot



Coil Lifter



Delivery Car



Shuttle Car

Long Span Cableveyor® with Glide Shoes



Long span specifications are a way of achieving longer travel strokes by having the Cableveyor glide on a guide rail. While normally this would cause wear on the tops and bottoms of the links, attaching glide shoes enables longer wear life, less energy required, and reduced running costs.

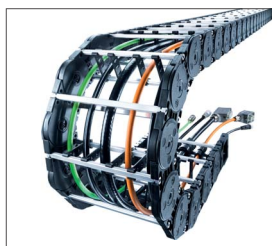

For very long travel lengths up to 200 m and over we also offer plastic cable carriers. Replaceable glide shoes made of a special, highly abrasion-resistant material with low friction coefficients increase the service life of the cable carrier systems many times over. For additional cable protection, covered types are available as well.

Wear Comparison *After 130,000 cycles



Glide shoe (Amount of wear: extremely low)



Links on the inner surface with no glide shoe attached (wear evident)

With no glide shoes **10x longer life** With glide shoes



Longer lifetime : 3.1 million cycles tested with highly abrasion-resistant glide shoes.

Other Solutions to Your Problems

FB Series Bucket Elevator Chain

A solid lubricant is bonded between the pins and bushes, and an O ring attached between links.

Merits

The solid lubricant minimizes chain elongation (pitch elongation), while the O ring prevents conveyed material from infiltrating between pins and bushes – and prevents the solid lubricant from escaping – giving FB Series twice the life of standard Bucket Elevator Chain.

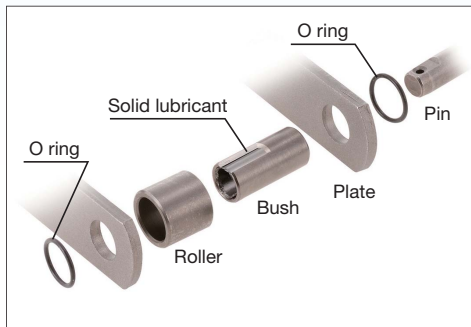

Thermally Sprayed Replaceable Tooth Sprockets

The sprocket teeth are replaceable, and the tooth bottoms have been specially thermally sprayed.

Merits

The entire replaceable tooth is hardened and the bottom specially thermally sprayed, giving the sprocket twice the wear life.

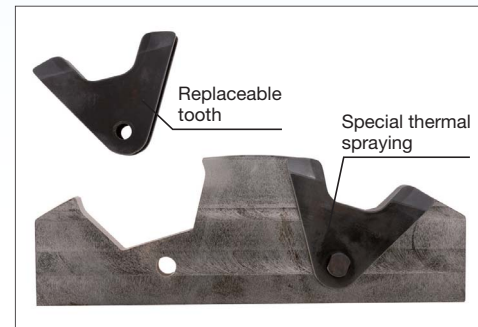

Tsubaki Lambda[®] Chain

Lambda Chain uses special oil-impregnated bushes for lube-free operation.

Merits

Reduced maintenance and replacement costs.
Wear life is drastically increased compared to standard chain in lube-free operation.



Dust Filtration Equipment Chain

The right combination of materials allows us to provide the ideal chain to meet your needs.

Merits

Our line-up includes a wear resistant series, corrosion resistant series, and low noise series.



Miter Gear Box

Distributes power laterally and across multiple shafts. Functions as a line shaft drive.

Merits

Allows for simple simultaneous drive using just one motor.

Equipment design can be made more compact.

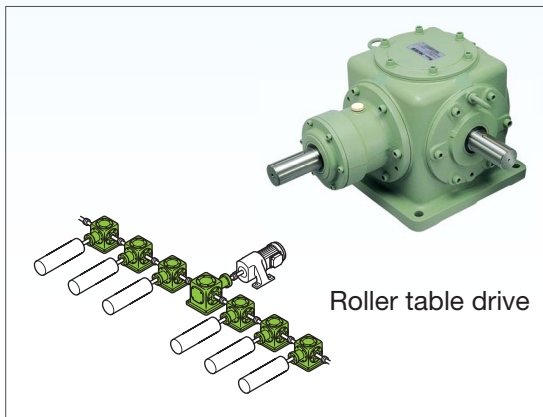

Roller table drive

Lini Power® Jack

A direct linear actuator (jack) that combines a trapezoidal or ball screw with a worm gear.

Merits

Choose from trapezoidal, ball, or high lead ball screws and multiple options to match your needs.



BS Series Cam Clutch

Cam clutches prevent low-speed backlash on conveyors and other equipment. Highly reliable thanks to their complete dust-proof enclosure and special cams.

Merits

Specially developed cams and a unique cam - roller construction give the BS Series Cam Clutch high impact resistance, high wear resistance, and good lubricating performance.



Pin Gear Drive Unit

Using our extensive experience with chain-type pin gear drives, Tsubaki's high performance rotary and linear pin gear drives are easy to install and have high performance.

Merits

Easy attachment - even a rough attachment precision gives smooth drive, and has a much higher kW rating than chains, allowing users to go a size down. Segmented units can be connected for attachment to larger equipment.

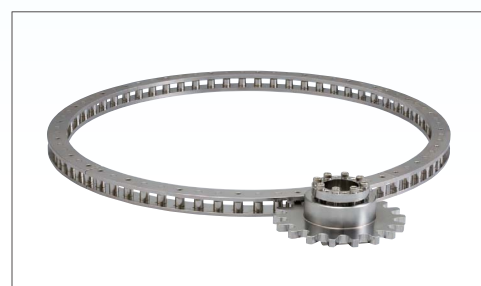

Tsubaki Eco & Eco

Let Tsubaki's Eco Products help you reduce

As a mechanical part and equipment manufacturer, the Tsubaki Group is working to develop environmentally-friendly products to reduce our environmental load ("ecology") and increase your bottom line ("economy").

Tsubaki Group Eco & Eco

Our Eco & Eco (Economy & Ecology) philosophy is to reduce our environmental load while giving our customers cost incentives and other measures to help their bottom line by providing them with environmentally friendly products.

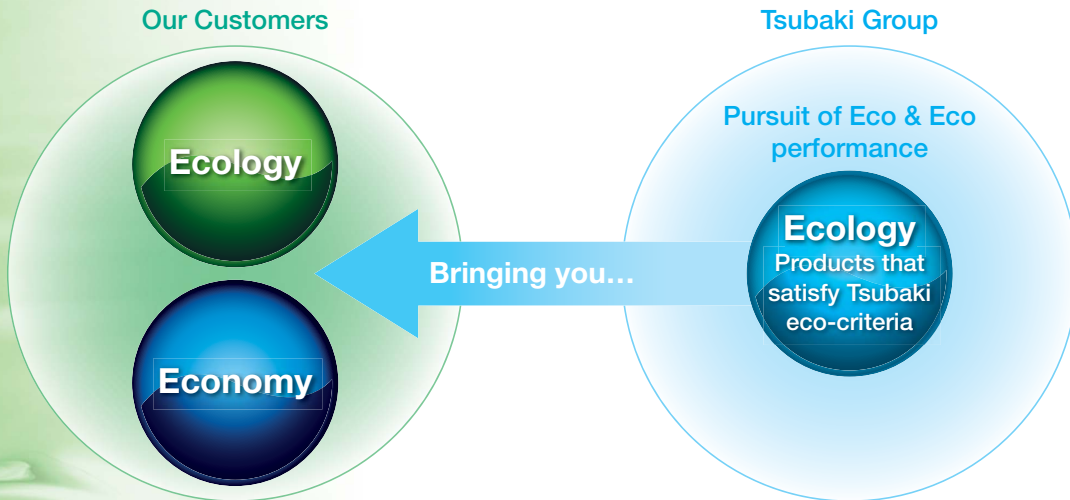

Eco & Eco Benefits for the Customer

By using Tsubaki's eco-friendly Eco Products, you can reduce your environmental load, improve working conditions, and increase efficiency and quality. And by incorporating Tsubaki Eco Products into your products, you can increase your own business opportunities by providing environmentally conscious products.

Use Tsubaki Eco Products to

- 1 bring procurement cost incentives to your customers by simplifying your products
- 2 reduce running costs by providing a longer running life, lube-free operation, etc., and
- 3 promote recycling and reduce disposal costs.

Tsubaki Group Environmental Activities

A major goal of the Tsubaki Group is to expand our line-up of eco-friendly products to serve as the cornerstone of eco-friendly operations. We are working hard to improve our products' performance to give them longer life and increased power in your operations, which will help reduce waste.

Points in developing Eco Products

- 1 Pursue eco-friendly designs and reduce the environmental load of procured items.
- 2 Introduce LCA methodology and make our environmental approach logical.
- 3 Contribute to society through business activities grounded in Eco Products.

energy costs and increase your bottom line

Tsubaki Eco Products

The Tsubaki Eco Link is our link to you and the environment, and your link to Ecology & Economy. The design is based on our popular roller chain link plate.



Eco Products catalog

Eco Points

We have divided our environmental activities into seven categories, which are reflected in the design and development of Eco Products.

- Uses fewer resources, reduces waste
- Contributes to a clean workplace/usage environment
- Easily disposable
- Contains no harmful chemicals
- Reduces energy consumption and CO₂ emissions
- Contributes to the surrounding environment
- Reusable

Examples of Tsubaki Eco Products

Power Cylinders



- Powered cylinder reduces power consumed
- 1/5 the power of hydraulic cylinders, 1/6 of pneumatic cylinders
- Contains no harmful chemicals
- Using Power Cylinders opens up new markets for your products as eco-friendly products

Power Cylinder LCA Evaluation

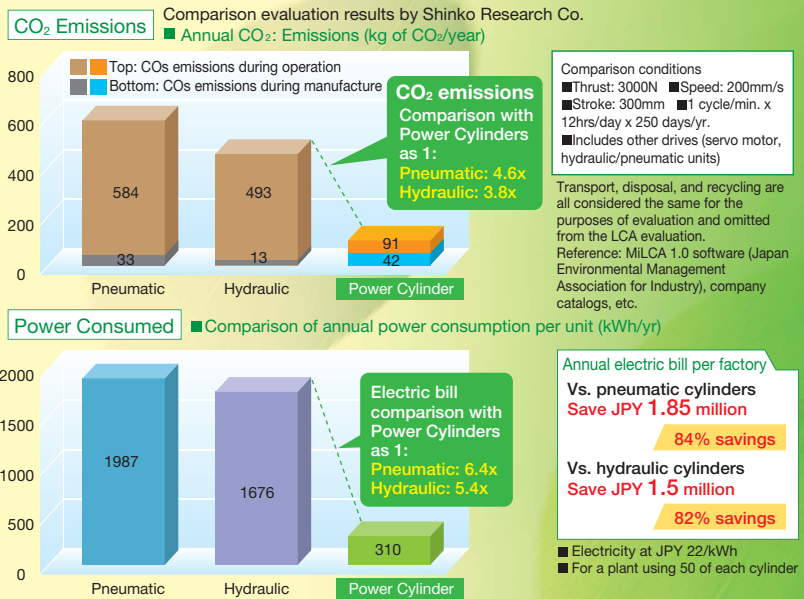

Bearing Roller Conveyor Chain



- Over three times the bush – roller wear life
- Longer life means less maintenance and lower running costs.
- Coefficient of friction is reduced by 1/3, greatly reducing the required power and allowing for a chain two sizes smaller to be selected.
- Greatly reduced CO₂ emissions thanks to lower required power.

CABLE CARRIER SYSTEM STEEL-LINE S/SX1252B AND S/SX1802B



- Longer lifetime, no lubrication required, environmental-friendly.
- Maintenance time is reduced, less waste generated.
- Fits to the millimeter, no additional material or space needed, less downtime due to open construction.
- Resource conservation, less waste generated.



The logos, brand or product names in this catalog are trademarks or registered trademarks of Tsubakimoto Chain Co. in Japan and other countries.

Catalog No KE1206 @ 2012/10 TSUBAKIMOTO CHAIN Co. Printed in Japan ©1,000